

Productspecificaties: U & L - Elementen Steenplaza-Dordrecht

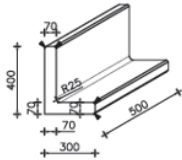

✓ =vellingkant 10mm
 52kg/stuk

L-element 50cm hoog
 Lengte = 50cm

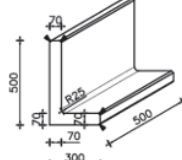

✓ =vellingkant 10mm
 61kg/stuk

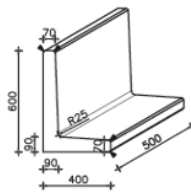

✓ =vellingkant 10mm
 79kg/stuk

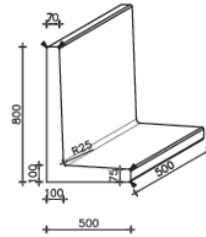

✓ =vellingkant 10mm
 112kg/stuk

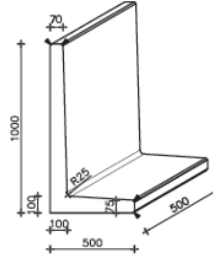

✓ =vellingkant 10mm
 129kg/stuk

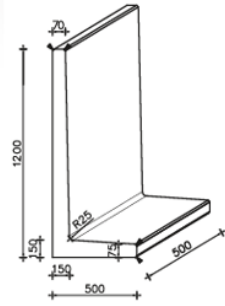

✓ =vellingkant 10mm
 206kg/stuk

**L-element
 40cm hoog Hoek**

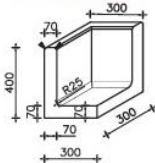

✓ =vellingkant 10mm
 40kg/stuk

**L-element
 50cm hoog Hoek**

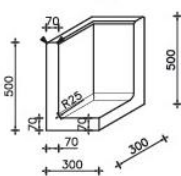

**L-element
 60cm hoog Hoek**

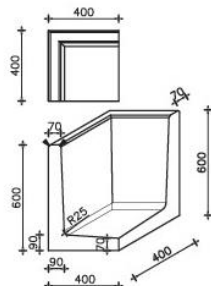

✓ =vellingkant 10mm
 95kg/stuk

**L-element
 80cm hoog Hoek**

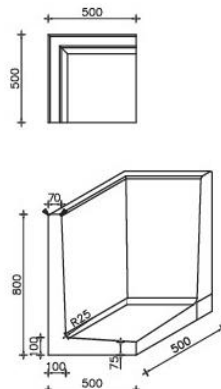

✓ =vellingkant 10mm
 162kg/stuk

**L-element
 100cm hoog Hoek**

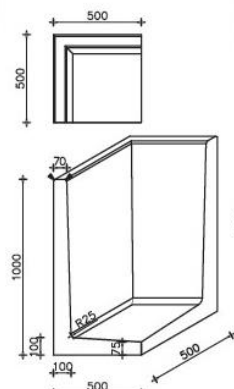

✓ =vellingkant 10mm
 194kg/stuk

**L-element
 120cm hoog Hoek**

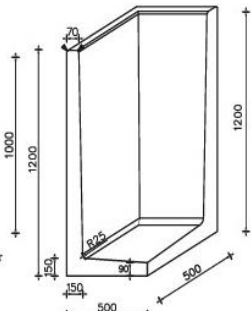

✓ =vellingkant 10mm
 309kg/stuk

Productspecificaties: U & L - Elementen Steenplaza-Dordrecht

U-element 30cm
 Lengte = 20cm

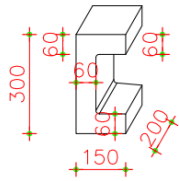

13.5kg/stuk

U-element 40cm breed
 Lengte = 30cm

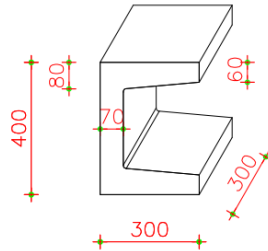

41.5kg/stuk

U-element 50cm breed
 Lengte = 40cm

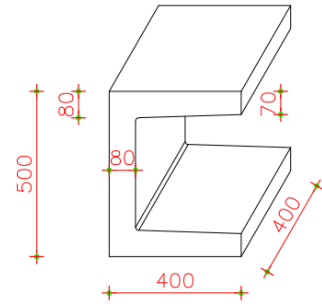

78kg/stuk

U-element eindstuk 50cm breed

Lengte = 40cm

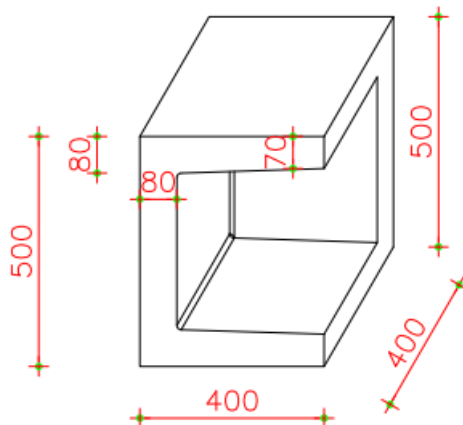
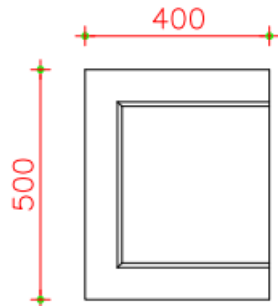

105kg/stuk